

# Eurofit Counter

## Product Parts

- 1 - Front Vertical Poles (x3)
- 2 - Back Vertical Poles (x2)
- 3 - Horizontal stabilizer bars (x3)
- 4 - Right Side Assembly
- 5 - Top Horizontal Poles (x4)
- 6 - Bottom Horizontal Poles (x4)
- 7 - Left Side Assembly
- 8 - Allen Wrench
- 9 - Counter
- 10 - Hardware Graphic
- 11 - Counter Graphic

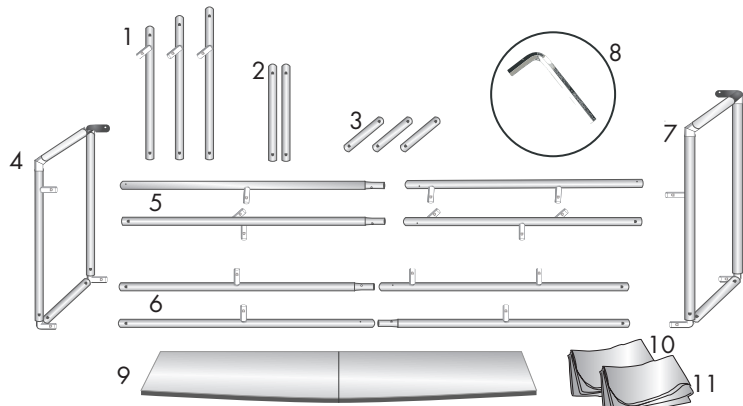

## Display Set-Up

### Step 1

Assemble the Counter starting with the Left and Right Side Assemblies and Bottom Horizontal Poles and work your way up to the top. See detailed layout below. Tighten all screws with the provided Allen Wrench (8).

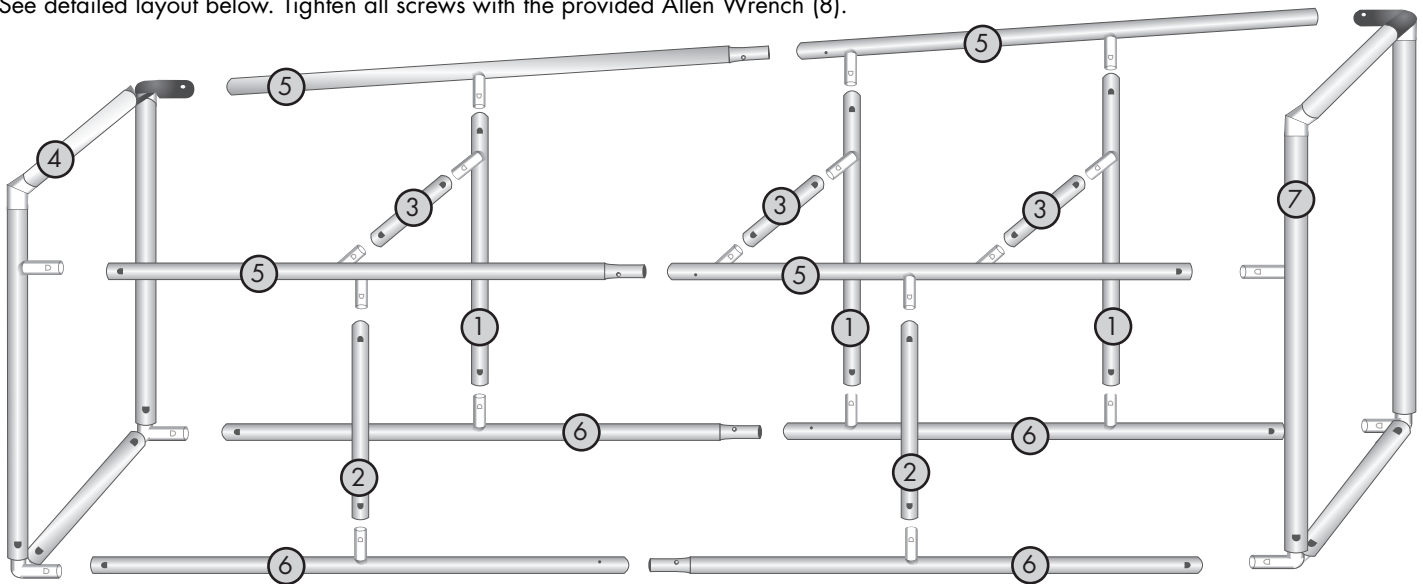

### Finished Assembly

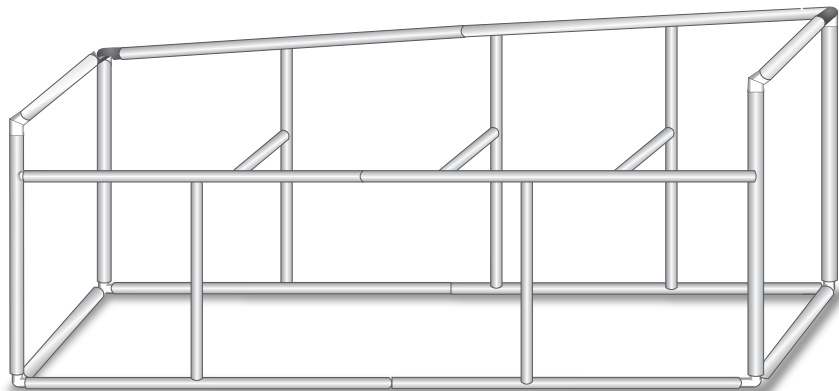

# Eurofit Counter

## Graphic Set-Up

### Step 2

Slide the Counter Graphic (11) over the straight side of the Counter (9) and Zip Closed. Set aside.

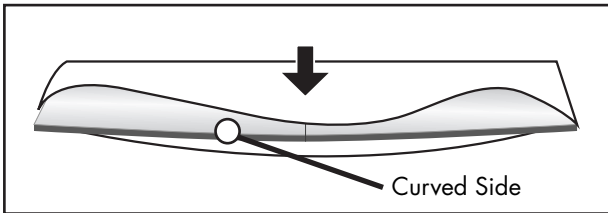

### Step 3

Locate the Zipper on the Hardware Graphic (10). With two people and with the Zipper facing the rear of the hardware, stretch and slide the graphic over the top of the hardware and slide down. Zip the three zippers closed.

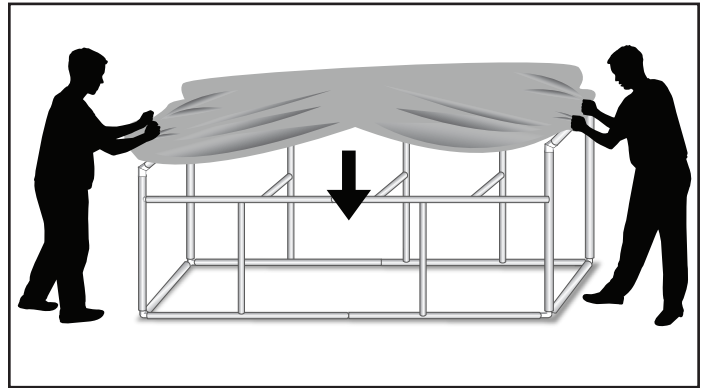

### Step 4

With the Curved Edge of the Counter (9) facing the front, slightly fold in half and tuck the corners of the counter (9) into the corners of the hardware and gently push downwards until the counter is flat.

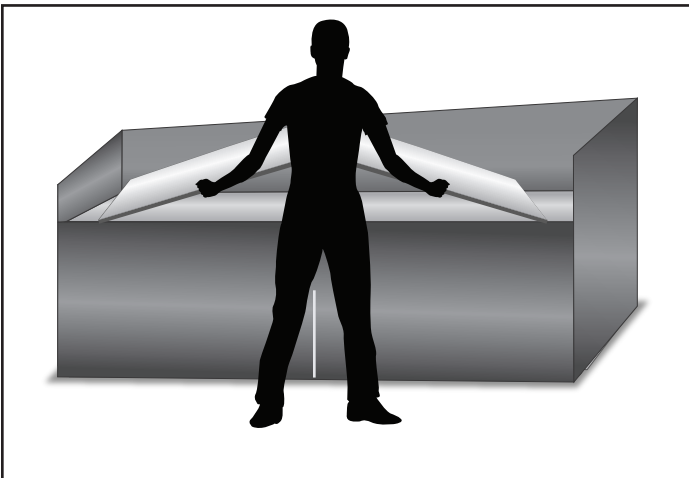

## Finished Product

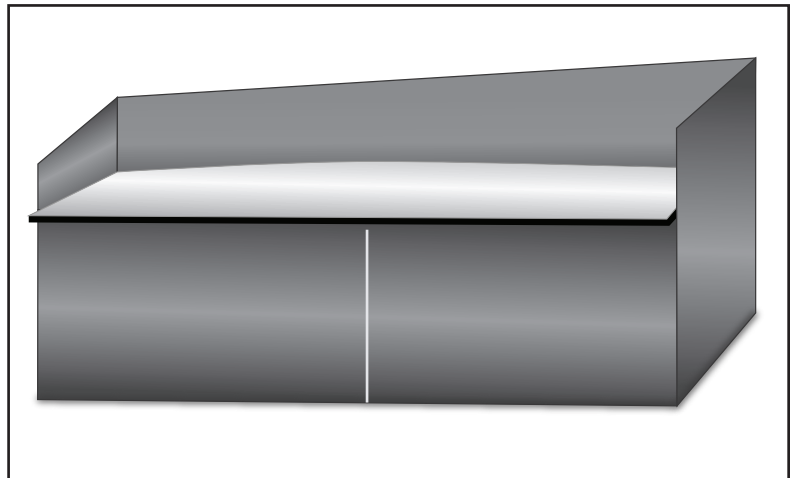

## Storage & Care

Store in a cool dry location. Machine wash cold, gentle cycle. Tumble dry no heat.